

TECHNISCHE INFORMATIONEN

Sortiment :	Sauggreifer
Kategorie :	Ovale
Serie :	4RP
Höhe :	32
Form :	Oval
Länge :	50mm
Breite :	16mm
Rohrinnendurchmesser :	IG G1/4"
Balgen :	0.5 Faltenbalg
Horizontalkraft :	40N
Vertikalkraft :	20N
Federweg :	3mm

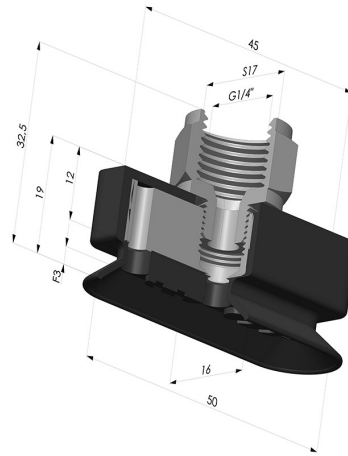

Varianten:

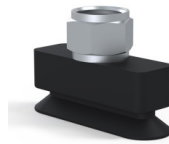

Variantenreferenz:

4RP 52NI F14

- Materiale: Nitril
- Shore-Härte: SH70