

TECHNISCHE INFORMATIONEN

Sortiment :	Sauggreifer
Kategorie :	Ovale
Serie :	4RP
Höhe :	31
Form :	Oval
Länge :	124mm
Breite :	60mm
Rohrinnendurchmesser :	AG G3/8"
Balgen :	0.5 Faltenbalg
Horizontalkraft :	300N
Vertikalkraft :	150N
Federweg :	6mm

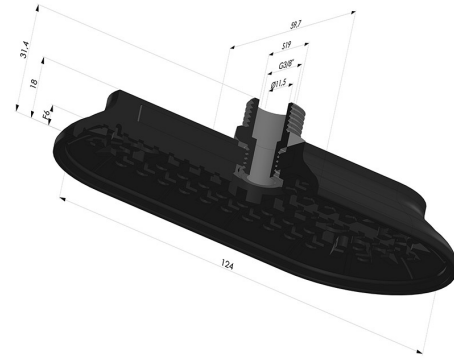

Varianten:



Variantenreferenz:

4RP 122NI M38

- Materiale: Nitril
- Shore-Härte: SH70