

TECHNISCHE INFORMATIONEN

Sortiment :	Sauggreifer
Kategorie :	Ovale
Serie :	4RP
Höhe :	23
Form :	Oval
Länge :	93mm
Breite :	32mm
Rohrinnendurchmesser :	AG G1/4"
Balgen :	0.5 Faltenbalg
Horizontalkraft :	125N
Vertikalkraft :	63N
Federweg :	3mm

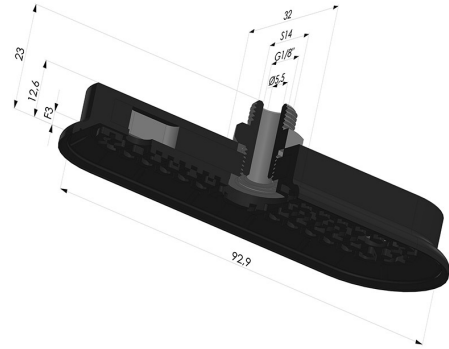

Varianten:



Variantenreferenz:

4RP 92NI M18

- Materiale: Nitril
- Shore-Härte: SH70