

TECHNISCHE INFORMATIONEN

Sortiment :	Sauggreifer
Kategorie :	Ovale
Serie :	4RP
Höhe :	25
Form :	Oval
Länge :	63mm
Breite :	23mm
Rohrinnendurchmesser :	AG G1/4"
Balgen :	0.5 Faltenbalg
Horizontalkraft :	60N
Vertikalkraft :	30N
Federweg :	3mm

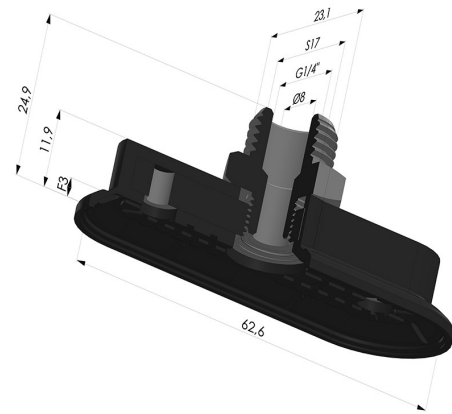

Varianten:



Variantenreferenz:

4RP 62NI M14

- Materiale: Nitril
- Shore-Härte: SH70