

**TECHNISCHE INFORMATIONEN**

<b>Balgen :</b>	2,5 Falten
<b>Federweg :</b>	7 mm
<b>Form :</b>	2,5 Falten
<b>Höhe :</b>	21
<b>Horizontalkraft :</b>	14 N
<b>Kategorie :</b>	Falten
<b>Lippendurchmesser :</b>	20 mm
<b>Rohrinnendurchmesser :</b>	M5
<b>Serie :</b>	96C
<b>Sortiment :</b>	Sauggreifer
<b>Vertikalkraft :</b>	7 N

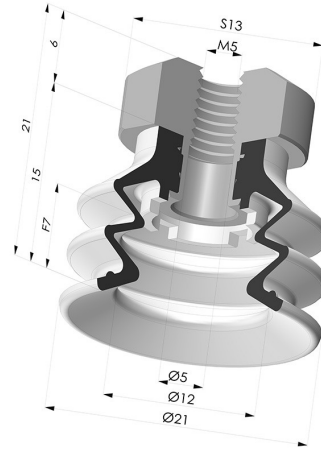

**Varianten:**



Variantenreferenz:  
**96C 20PU FM5**

- Farbe: Grün / Gelb
- Materiale: Polyurethan
- Shore-Härte: SH60 / SH30

**Ähnliche Produkte:**



**Abtrennbarer Halter IG M5**

Produktreferenz: 9PM5-2

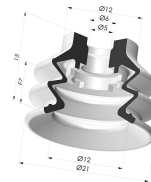

**Sauggreifer 2.5 Falten Serie 96C Ø 20MM**

Produktreferenz: 96C 20-- A